User Manual

SG2K-S / SG2K5-S / SG3K-S /
SG3K-D / SG5K-D

**PV Grid-Connected
Inverter**



About This Manual

The manual mainly describes the product information, guidelines for installation, operation and maintenance. The manual cannot include complete information about the photovoltaic (PV) system. You can get additional information about other devices at www.sungrowpower.com or on the webpage of the device manufacturer.

Applicability

This manual is applicable to the following inverter types:

- SG2K-S
- SG2K5-S
- SG3K-S
- SG3K-D
- SG5K-D

They will be referred to as “inverter” hereinafter unless otherwise specified.

Target Group

This manual is intended for:

- qualified personnel who are responsible for the installation and commissioning of the inverter; and
- inverter owners who will have the ability to interact with the inverter.

How to Use This Manual





Read the manual and other related documents before any work on the inverter is carried out. Documents must be stored carefully and be available at all times.

All rights to the content of this manual are owned by Sungrow Power Supply Co., Ltd. (hereinafter “SUNGROW”). No part of this document can be modified, distributed, reproduced or published in any form or by any means without prior written permission from SUNGROW.

Contents may be periodically updated or revised due to product development. The information in this manual is subject to change without notice. The latest manual can be acquired at www.sungrowpower.com.

Symbols

Safety instructions will be highlighted with the following symbols.

Symbol	Explanation
 DANGER	Indicates a hazard with a high level of risk that, if not avoided, will result in death or serious injury.
 WARNING	Indicates a hazard with a medium level of risk that, if not avoided, could result in death or serious injury.
 CAUTION	Indicates a hazard with a low level of risk that, if not avoided, could result in minor or moderate injury.
NOTICE	Indicates a situation that, if not avoided, could result in equipment or property damage.
	Indicates additional information, emphasized contents or tips that may be helpful, e.g. to help you solve problems or save time.

Contents

About This Manual	I
1 Safety.....	1
1.1 General Safety	1
1.2 Inverter	2
1.3 Skills of Qualified Personnel.....	3
2 Product Introduction	4
2.1 Intended Use.....	4
2.2 Inverter	5
2.3 Energy Meter (optional).....	7
2.4 Function Description.....	8
2.4.1 Basic Function.....	8
2.4.2 External Demand Response	8
2.4.3 Reactive Power Regulation.....	9
2.4.4 Power Quality Response.....	9
3 Unpacking and Storage.....	10
3.1 Unpacking and Inspection	10
3.2 Identifying the Inverter	10
3.3 Delivery Contents	12
3.4 Storage of Inverter.....	13
4 Mechanical Mounting	14
4.1 Safety during Mounting	14
4.2 Location Requirements	14
4.3 Installing the Inverter	16
4.4 Installing the Energy Meter.....	18
5 Electrical Connection	19
5.1 Terminal Description.....	20
5.2 Grounding the Inverter	21
5.3 Grid Connection	22

5.3.1 AC Side Requirements	22
5.3.2 Assembling the AC Connector	23
5.3.3 Installing the AC Connector	24
5.4 PV Connection	24
5.4.1 PV Input Configuration	25
5.4.2 Assembling the PV Connector	26
5.4.3 Installing the PV Connector	28
5.5 RS485 Connection	29
5.6 Meter Connection	29
5.6.1 On the Meter Side	30
5.6.2 On the Inverter Side	32
5.7 DRM Connection to an External Device	33
6 Commissioning	35
6.1 Inspection before Commissioning	35
6.2 Button Function	35
6.3 Commissioning Procedure	36
7 LCD Operation	37
7.1 Button Function	37
7.2 Main Screen	37
7.3 Menu Structure	39
7.4 Viewing Running Info	39
7.5 Advanced Settings	40
7.5.1 Inputting the Password	40
7.5.2 Setting Protective Parameters	40
7.5.3 Zero-export Setting	43
7.5.4 PF Setting	43
7.5.5 Parameter Reset	44
7.5.6 DRM Switch Setting	44
7.5.7 GND Detection	44
7.5.8 Energy Adjustment	44
7.5.9 Setting Communication Parameter	44
7.5.10 Ethernet Configuration	45

7.6	Starting/Stopping the Inverter	45
7.7	Viewing the Error Record	45
7.8	Setting the Time	45
7.9	Setting the Country.....	46
7.10	Viewing Device Info.....	48
8	Troubleshooting and Maintenance	49
8.1	Troubleshooting.....	49
8.1.1	For the Indicator Circle.....	49
8.1.2	For the Errors on the App or LCD Screen.....	49
8.2	Routine Maintenance	55
9	System Decommissioning.....	57
9.1	Disconnecting the Inverter.....	57
9.2	Dismantling the Inverter	58
9.3	Disposing of the Inverter	58
10	Appendix	59
10.1	Technical Data.....	59
10.1.1	–S Series.....	59
10.1.2	–D Series.....	60
10.2	Exclusion of Liability.....	62
10.3	About Us	63

1 Safety

The inverter has been designed and tested strictly according to international safety regulations. Read all safety instructions carefully prior to any work and observe them at all times when working on or with the inverter.

Incorrect operation or work may cause:

- injury or death to the operator or a third party; or
- damage to the inverter and other properties belonging to the operator or a third party.

All detailed work-related safety warnings and notes will be specified at critical points in this manual.

1.1 General Safety

PV Panels

Please follow the safety instructions related to the PV strings.

DANGER

Lethal voltage!

PV strings will produce electrical power when exposed to sunlight and can cause a lethal voltage and an electric shock.

Only qualified personnel can perform the wiring of the PV panels.

Utility Grid

Please follow the regulations related to the utility grid.

NOTICE

All electrical connections must be in accordance with local and national standards.

Only with the permission of the utility grid, the inverter can be connected to the utility grid.

1.2 Inverter

There is a warning label on the inverter body.



Disconnect the inverter from all the external power sources before service!



10 min

Do not touch live parts until 10 minutes after disconnection from the power sources.



There is a danger from a hot surface that may exceed 60°C.



Danger to life due to high voltages!
Only qualified personnel can open and service the inverter.



Check the user manual before service!

DANGER

Danger to life from electric shocks due to live voltage

- Do not open the enclosure at any time. Loss of any or all the rights may follow if otherwise.
- When the enclosure lid is removed, live components can be touched which can result in death or serious injury due to electric shock.

Danger to life from electric shock due to damaged inverter

- Only operate the inverter when it is technically faultless and in a safe state.
- Operating a damaged inverter can lead to hazardous situations that can result in death or serious injuries due to electric shock.

WARNING

Risk of inverter damage or personal injury

Do not pull out the PV connectors and AC connector when the inverter is running. De-energize the inverter from dual power sources and verify that there is no voltage.

 **WARNING**

All the warning labels and nameplate on the inverter body:

- must be clearly visible; and
- must not be removed, covered or pasted.

 **CAUTION**

Risk of burns due to hot components!

DO not touch the hot parts (such as heat sink) during operation. Only the buttons and the optional DC switch can be touched.

NOTICE

Only qualified personnel can perform the country setting.

Unauthorized alteration of the country setting may cause a breach of the type-certificate marking.

Inverter damage due to electrostatic discharge (ESD).

By touching the electronic components, you may damage the inverter. For inverter handling, be sure to:

- **avoid any unnecessary touching; and**
- **wear a grounding wristband before touching any connections.**

1.3 Skills of Qualified Personnel

Qualified personnel must have the following skills:

- training in the installation and commissioning of the electrical system, as well as the dealing with hazards;
- knowledge of the manual and other related documents; and
- knowledge of the local regulations and directives.

2 Product Introduction

2.1 Intended Use

The inverters, which are single-phase string inverters without transformer, are the crucial units between the PV strings and the utility grid in a PV power system.

The inverter is dedicated to converting the DC power generated by the PV strings into the AC power, which conforms to the parameters of the local utility grid and is fed into the utility grid.

WARNING

Any use other than the intended use is not permitted.

The inverter must only be operated with PV strings of protection class II in accordance with IEC 61730, application class A. It is not permitted for the positive pole or the negative pole of the PV strings to be grounded. A permanent destroy to the inverter may follows if otherwise.

The intended use example is shown in **Fig. 2-1**.

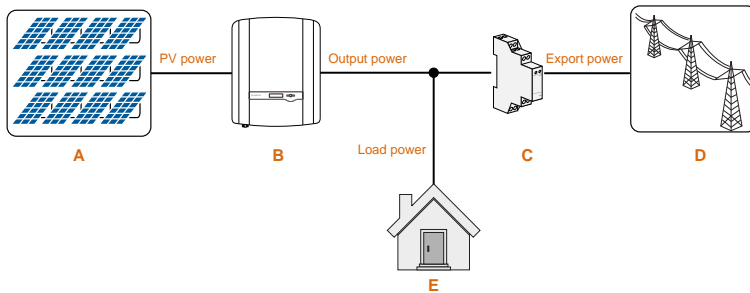

Fig. 2-1 Application in a PV Power System

Item	Description	Remarks
A	PV strings	Monocrystalline silicon, polycrystalline silicon and thin-film without grounding.
B	Inverter	SG2K-S, SG2K5-S, SG3K-S, SG3K-D and SG5K-D.
C	Sungrow single-phase meter (optional)	Measures the export power and communicate with the inverter via an RS485 connection.

Item	Description	Remarks
D	Utility grid	Grid earthing system types: TT, TN.
E	Household load	Devices that consume energy.

NOTICE

For the TT utility grid, the N line voltage to ground must be less than 30 V.

2.2 Inverter

Appearance

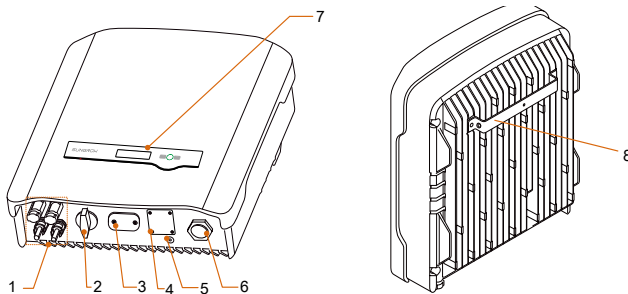

Fig. 2-2 Inverter Appearance (-D series for example)

* The image shown here is for reference only. The actual product you receive may differ.

Item	Name	Description
1	PV terminals	To connect the PV strings. A pair or two pairs.
2	DC switch (optional)	To disconnect the DC current safely.
3	RS485 terminal	To connect the communication module, such as Wi-Fi module.
4	Meter DRM terminal	Connections to the energy meter and external Demand Response Enabling Device (DRED).
5	Second PE terminal	For reliable grounding.
6	AC terminal	To feed power into the utility grid.
7	LCD display panel	Human-computer interaction interface, including a screen, an indicator and two buttons.
8	Mounting rack	To hang the inverter to the wall-mounting bracket.

Dimensions and Weight

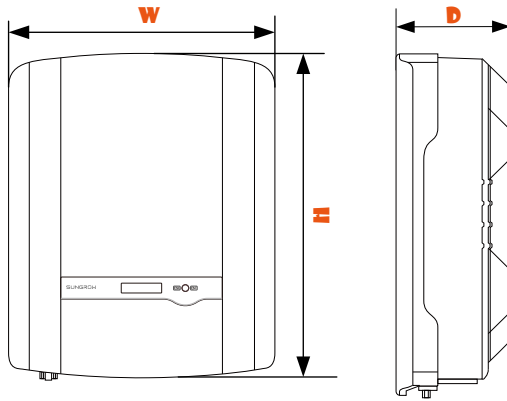

Fig. 2-3 Dimensions of the Inverter

Tab. 2-1 Dimensions and Weight

Type	W (mm)	H (mm)	D (mm)	Weight (kg)
SG2K-S / SG2K5-S / SG3K-S	300	370	125	8.5
SG3K-D / SG5K-D	360	390	133	11.5

LCD Display Panel

The LCD display panel with a screen, an indicator and two buttons is on the front of the inverter.

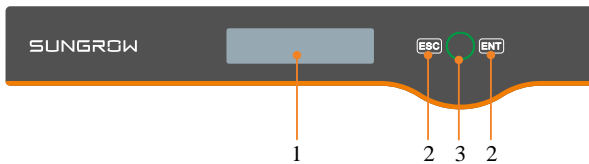

Fig. 2-4 LCD Display Panel

No.	Name	Description
1	LCD screen	Display the power, state, running information and parameters.
2	Buttons	ESC / ENT. User can view or set parameters via the buttons. For detailed functions, see Tab. 6-1 .

No.	Name	Description
3	Indicator	Green / red / orange. User can observe the colour and blinking frequency to get the current state of the inverter. For detailed definition, see Tab. 6-2.

2.3 Energy Meter (optional)

The SUNGROW Energy Meter is installed next to the main switch to detect the electrical measured values at the grid-connected point. It communicates with the inverter via an RS485 connection. The dimensions are shown below.

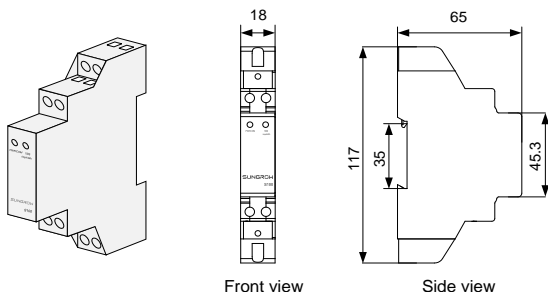

Fig. 2-5 single-phase Meter Dimensions (unit: mm)

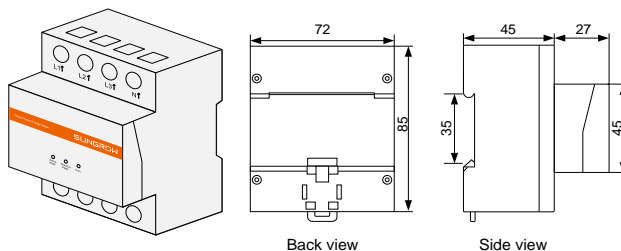

Fig. 2-6 Three-phase Meter Dimensions (unit: mm)



- The single-phase Energy Meter and the three-phase Energy Meter are alternative and delivered separately. The meter figures in this document have been created for the single-phase Energy Meter unless otherwise specified.
- For details about the Energy Meter, please refer to the Quick Installation Guide for it.

2.4 Function Description

2.4.1 Basic Function

- Conversion function
Inverter converts the DC power into the AC power, which conforms to the grid requirement of its installation country.
- Data storage
Inverter archives essential data including running information and error records.
- Parameter configuration
Inverter provides various parameter configurations for optimal operation. You can set the country via the SolarInfo Home App or SolarInfo Bank server, if you need a more professional setting, please contact Sungrow.
- Communication interface
You can choose the RS485 terminal for connecting a communication module to the PV system, such as Wi-Fi module.
- Earth fault alarm
If an earth fault occurs, the error code will be displayed on the LCD screen. The buzzer inside the inverter will beep to signal an external alarm.
- Protective function
The protective functions are integrated in the inverter, including short circuit protection, grounding insulation resistance surveillance, residual current protection, anti-islanding protection, DC overvoltage / over-current protection, etc.

2.4.2 External Demand Response

The inverter provides a RJ45 port for connecting to a demand response enabling device (DRED). The DRED asserts demand response modes (DRMs). The inverter detects and initiates a response to the supported demand response commands within 2 s. The following table lists the DRMs supported by the inverter.

Tab. 2-2 Demand Response Modes (DRMs)

Mode	Explanation
DRM0	The inverter is in the state of standby.
DRM5	The export power to the grid is 0.

Mode	Explanation
DRM6	The export power to the grid is no more than 50% of the rated power.
DRM7	The export power to the grid is no more than 75% of the rated power.
DRM8	The export power to the grid is 100% of the rated power, but subject to the constraints from other active DRMs.

2.4.3 Reactive Power Regulation

The inverter is capable of operating in reactive power regulation modes for the purpose of providing support to the grid. These various operating modes can be enabled or disabled via the LCD menu.

- **PF:** Fixed power factor mode.
- **Qt:** Fixed reactive power mode.
- **Q(p):** The PF of the inverter output varies in response to the output power of the inverter.
- **Q(u):** The reactive power output of the inverter varies in response to the grid voltage.

2.4.4 Power Quality Response

The inverter supports two power quality response modes.

- Power response for voltage variations

Define the response curve with four reference voltages, which can be set via the LCD menu. The power output will vary in response to the voltage curve. Refer to “**7.5.2 Setting Protective Parameters**” for details.

- Power response for frequency variations

The inverter provides built-in over/under frequency protective threshold values. Refer to “**Tab. 7-7 Protective Parameters of Grid Standards**” for details. When the grid frequency is lower than the under-frequency limit or higher than the over-frequency limit, the inverter will be disconnected from the grid.

When there is an increase in grid frequency which exceeds 50.25 Hz, the inverter will reduce the power output linearly with an increase of frequency until the end value (52.00 Hz) is reached.

3 Unpacking and Storage

3.1 Unpacking and Inspection

The inverter is thoroughly tested and strictly inspected before delivery. Damage may still occur during shipping. Conduct a thorough inspection after receiving the device.

1. Check the packaging for any visible damage.
2. Check the inner contents for damage after unpacking.
3. Check the delivery contents for completeness according to the packaging list.

Contact SUNGROW or the distributor in case of any damaged or missing components.

It is the best choice to store the inverter in the original packaging. So, do not dispose of it.

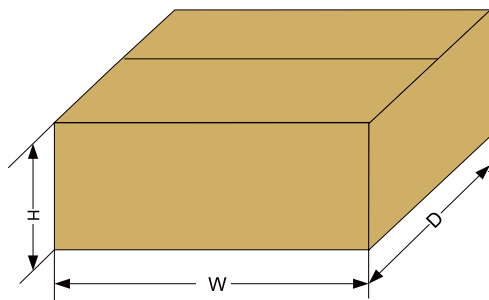

Fig. 3-1 Single Inverter Packaging

Inverter Type	W (mm)	H (mm)	D (mm)
SG2K-S / SG2K5-S / SG3K-S	545	215	375
SG3K-D / SG5K-D	545	215	445

3.2 Identifying the Inverter

The nameplate clearly identifies the product. It is attached to the side of the inverter.

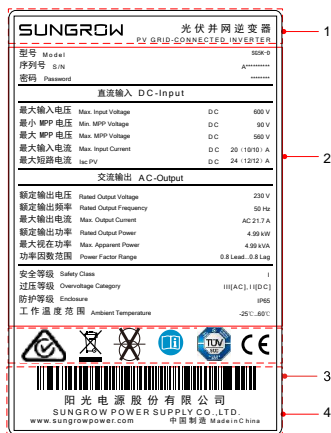

Fig. 3-2 Nameplate of Inverter

* The image shown here is for reference only. The actual product you receive may differ.

Item	Description	Item	Description
1	SUNGROW logo and product type	3	Marks of certification institutions
2	Technical data	4	Barcode, company name and origin

Tab. 3-1 Description of Icons on the Nameplate

Icon	Description
	Regulatory compliance mark.
	Do not dispose of the inverter together with household waste.
	The inverter does not have a transformer.
	Refer to the corresponding instructions.
	TUV mark of conformity.
	CE mark of conformity.

3.3 Delivery Contents

Standard Delivery

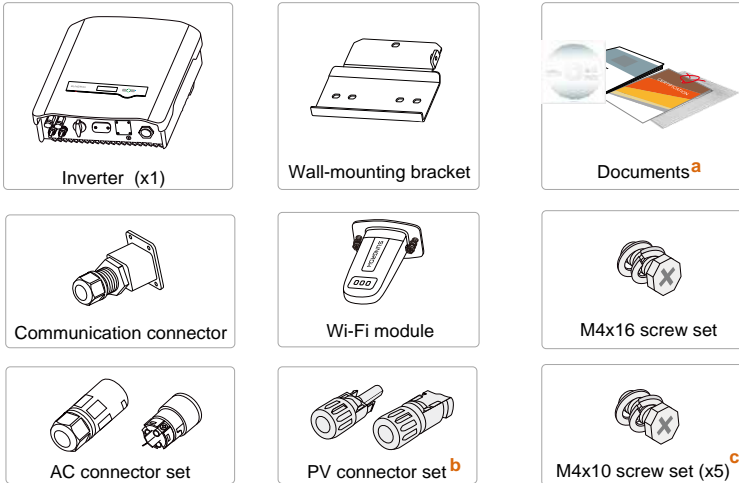
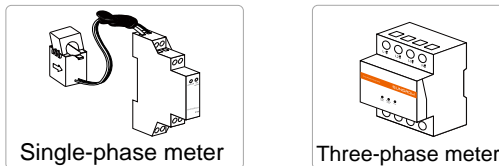

Fig. 3-3 Delivery Contents

- The documents include the Quick User Manual, 1 CD, quality certificates, packaging list and product test reports.
- One pair for the –S series and two pairs for the –D series.
- One M4 x 10 screw set is for external grounding and the other four are for the communication connector.

Optional Accessory



- The single-phase Energy Meter and the three-phase Energy Meter are alternative. The meter figures in this document have been created for the single-phase Energy Meter unless otherwise specified.
- If you purchase the accessory, they will be delivered separately.

3.4 Storage of Inverter

If you do not install the inverter immediately, choose an appropriate location to store it.

- Store the inverter in the original packaging with the desiccant inside.
- The storage temperature should be always between -30°C and $+85^{\circ}\text{C}$, and the storage relative humidity should be always between 0 and 100 %.
- If there is more than one inverter to be stored, the maximum layer is 9.
- The packaging should be upright.

4 Mechanical Mounting

4.1 Safety during Mounting

DANGER

Make sure there is no electrical connection before installation.

In order to avoid electric shock or other injury, be sure there is no electricity or plumbing installations before drilling holes.

CAUTION

Risk of injury due to improper handling

- **The weight can cause injuries, serious wounds, or bruise.**
- **Always follow the instructions when moving and positioning the inverter.**

System performance loss due to bad ventilation!

- **The inverter requires good ventilation during operation. Keep it upright and nothing covering the heat sink.**

NOTICE

Wear gloves to avoid scratches when mounting the inverter.

4.2 Location Requirements

The inverter with IP65 can be installed indoors or outdoors.

Selecting an optimal location for the inverter is critical for its operating safety as well as the expected efficiency and service life. Considerations for the location include:

1. The concrete wall should be suitable for the weight and dimensions of the inverter.
2. Install the inverter where it is convenient for installation, cable connection and service.

3. Do not install the inverter in the living area or bedrooms. The noise during its operation may affect daily life.
4. The location should be not accessible to children.
5. The ambient temperature and relative humidity should meet the following requirements.



6. The location should be not flammable materials (except the wooden wall), away from flammable materials or gas, and not enclosed.

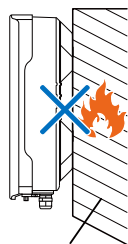

Flammable wall

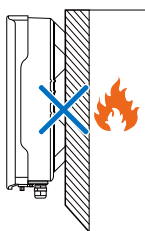

Flammable material or gas near the installation

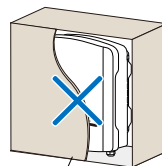

Enclosed cabinet

7. The shaded side of the building would be better to prevent the inverter from exposure to the sun, rain, and snow.

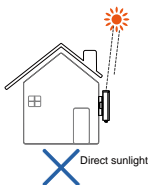
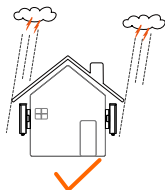
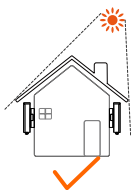

Direct sunlight

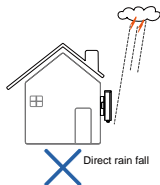

Direct rain fall

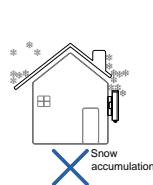

Snow accumulation

8. Place at eye level for easy viewing:

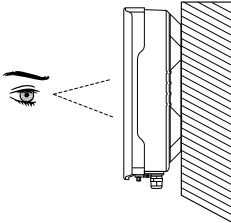

9. Install vertically for good heat dissipation.

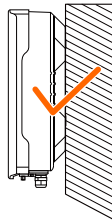

10. Never install the inverter horizontally, or with a forward tilt or with a backward tilt or even with upside down. The horizontal installation could result in damage to the inverter.

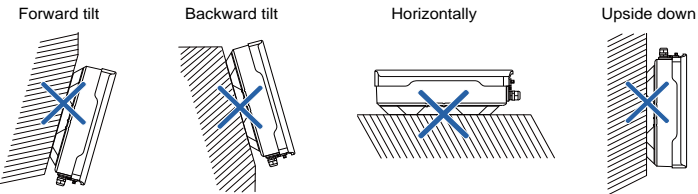

11. Clearance requirement and multiple installation:

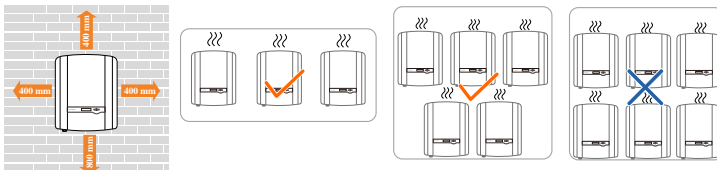

For multi-row installation, the distance between two adjacent rows should be at least 400 mm.

4.3 Installing the Inverter

Inverter is installed on the wall by means of wall-mounting bracket and the expansion plug sets.

The expansion plug set shown below is recommended for the installation. They are not included in the delivery scope.

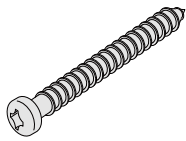

Self-tapping screw M6

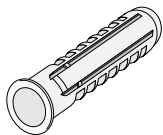

Expansion tube



Fender washer



Spring washer

1. Place the wall-mounting bracket to the wall and adjust it until it is in a horizontal position. Mark the positions.

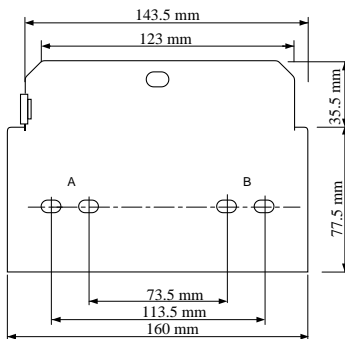

2. Drill holes and install the wall-mounting bracket. The depth of the holes should be about 70 mm.

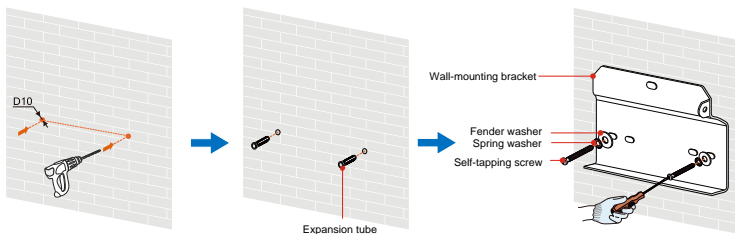

3. Mount the inverter to the bracket, and secure it with an M4 screw (torque: 1.5 N·m).

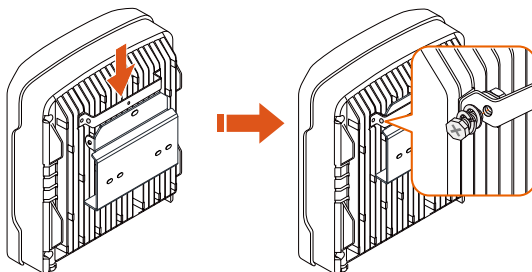

- To protect the inverter from theft, you can lock it with a padlock. The padlock is purchased by the user if necessary. The hole diameter is about 8 mm.

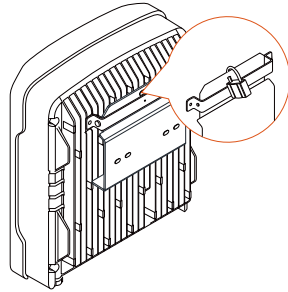

- Remove the waterproof lid from RS485 terminal and install the communication module to the inverter. The following figure takes the Wi-Fi module as an example.

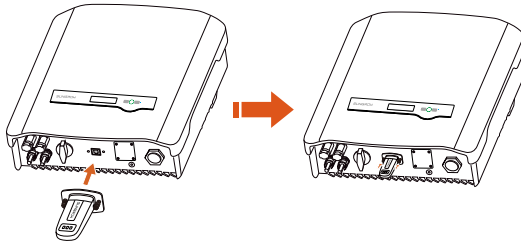

4.4 Installing the Energy Meter

The SUNGROW Energy Meter should be installed between the grid and the load. It supports a 35 mm DIN-rail installation, as shown in the following figure.

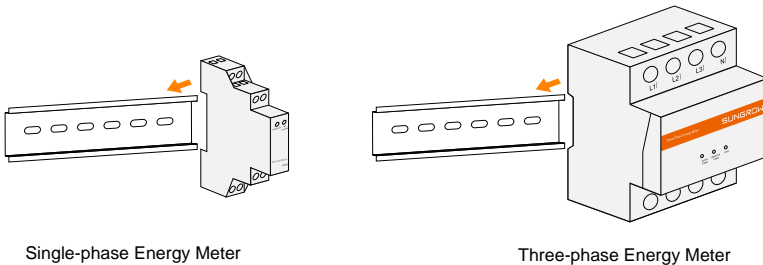

Single-phase Energy Meter

Three-phase Energy Meter

Fig. 4-1 Installing the Meter to the Rail

5 Electrical Connection

Prior to any electrical connections, keep in mind that the inverter has dual power supplies. It is mandatory for the technical personnel to wear personal protective equipments (PPE) during the electrical work.

DANGER

Danger to life due to a high voltage inside the inverter

- **Make sure that the cables are not live before electrical connection.**
- **Do not turn on the AC circuit breaker until all the electrical connections are completed.**

WARNING

Improper operation during the wiring process can cause fatal injury to the operators or unrecoverable damage to the inverter.

Only qualified personnel can perform the wiring work.

All cables must be firmly attached, undamaged, properly insulated and adequately dimensioned.

NOTICE

Comply with the safety instructions related to the PV strings and the regulations related to the utility grid.

All electrical connections must be in accordance with local and national standards.

Only with the permission of the utility grid, the inverter can be connected to the utility grid.

Electrical connections of the inverter include grounding, PV connection, AC connection and communication connection.

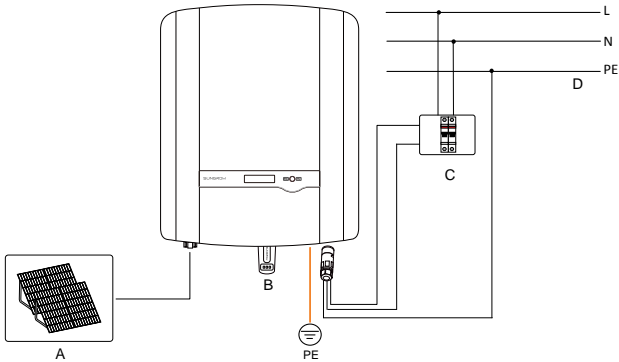

Fig. 5-1 Electrical Connection Diagram

Item	Name	Remarks
A	PV strings	-S series: one pair of PV terminals. -D series: two pairs of PV terminals.
B	Wi-Fi module	RS485 communication.
C	AC circuit breaker	Used as a protective device during electrical connection. User equips this device according to the maximum output voltage and current. The PE wire of the AC terminal must be directly connected to the grounding bar. Do not connect it to protection devices such as the circuit breaker.
D	Utility grid	Nominal line-to-neutral voltage of the utility grid is 230 Vac.

5.1 Terminal Description

All electrical terminals are located at the bottom of the inverter.

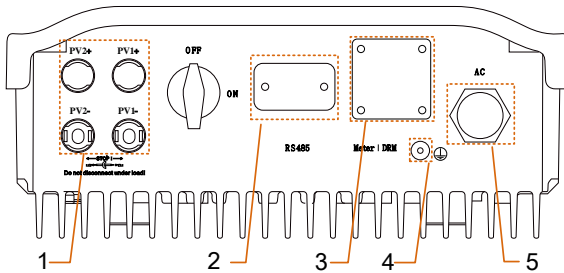

Fig. 5-2 Terminal Description

* Image shown here is for reference only. The actual product you receive may differ.

Tab. 5-1 Terminal Descriptions

Item	Terminal	Description
1	PV terminals	MC4 terminals for PV inputs. -S series: one pair of PV terminals. -D series: two pairs of PV terminals.
2	RS485 terminal	To connect a Wi-Fi module.
3	Meter DRM terminal	The left hole is for meter communication and the right is for DRED communication.
4	Second PE terminal	For reliable grounding.
5	AC terminal	The AC terminal to the utility grid.

5.2 Grounding the Inverter

All non-current carrying exposed metal parts of the equipment and other enclosures in the PV power system should be grounded, e.g. PV strings frame and inverter enclosure.

A second Protective Earth (PE) terminal is equipped at the bottom of the inverter. Be sure to connect this PE terminal for reliable grounding and ensure that the grounding resistance should be less than 10 Ohm.

⚠ WARNING

In no case shall the second PE connection substitute for the PE connection in the AC terminal block. Be sure to connect both PE terminals for reliable grounding. The loss of any or all the warranty rights may follow if otherwise.

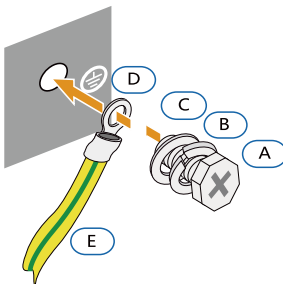

Item	Description
A	Screw (M4x10 mm)
B	Spring washer
C	Washer
D	Cable socket
E	Yellow-green cable

Fig. 5-3 Second PE Connection

* The cross-section of the PE cable should be at least 10 mm² if copper or 16

mm² if aluminum. The cable and cable socket are not included in the delivery scope.

5.3 Grid Connection

The inverter is connected to the grid via 3 wires (L, N and PE).

Inverter is equipped with the waterproof direct plug-in connector which matches the AC terminal at the bottom of the inverter.

5.3.1 AC Side Requirements

AC Circuit Breaker

An independent two-pole AC circuit breaker for the inverter must be installed at the output side for safe disconnection. The recommended specifications are as follows:

Inverter Type	Specification
SG2K-S / SG2K5-S / SG3K-S / SG3K-D	25 A
SG5K-D	32 A

NOTICE

It is not allowed for several inverters to use the same AC circuit breaker.

Residual Current Device

With an integrated universal current-sensitive residual current monitoring unit inside, the inverter will disconnect immediately from the mains power as soon as a fault current with a value exceeding the limit has been detected.

However if an external residual current device (RCD) is mandatory, the switch must be triggered at a failure current of 300 mA or higher.

AC Cable Requirements

The recommended specifications are shown in the following table

Type	Cross-section (mm ²)		Cable diameter (mm)	
	Range	Recommended	Range	Recommended
SG2K-S / SG2K5-S / SG3K-S / SG3K-D	4...6	4	10...14	14
SG5K-D	4...6	6	10...14	14

5.3.2 Assembling the AC Connector

1. Lead the AC cable through the cable gland and the housing.
2. Remove the cable jacket by 40 mm, and strip the wire insulation by 8-15 mm.

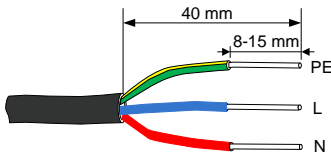
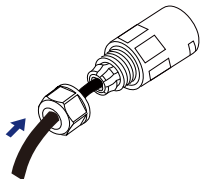

3. Fully insert the conductors to the corresponding terminal and tighten the screws with the torque 0.8 N·m. Pull cables outward to check whether they are firmly installed.

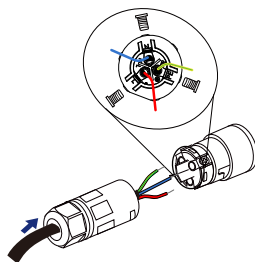

NOTICE

Observe the terminal layout of AC connector. Do not connect the phase lines to "PE" terminal, otherwise the inverter will not function properly and the loss of any or all the warranty rights may follow.

4. Assemble the housing, the terminal block and cable gland. Make sure that the rib of the terminal block and the groove on the housing engage perfectly until a "Click" is heard or felt.

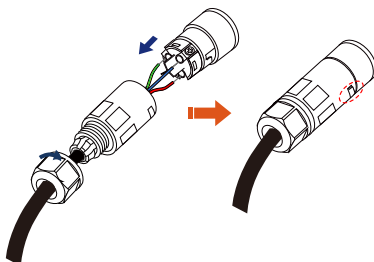

5.3.3 Installing the AC Connector

1. Disconnect the AC circuit breaker and secure it against reconnection.
2. Measure the voltage and frequency of the grid-connected point to ensure that they are within the specified range listed in “10.1 Technical Data”.
3. Align the AC connector and the AC terminal and mate them together by hand until a “Click” is heard or felt.

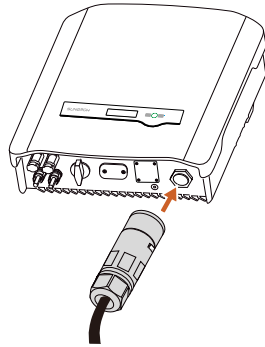

4. Connect the other ends. Connect “PE” conductor to the grounding electrode. Connect “L” and “N” conductors to the AC circuit breaker.
5. Pull all the lines outward to check whether they are firmly installed.

5.4 PV Connection

NOTICE

There is a risk of inverter damage! The following requirements should be met; otherwise they will lead to loss of any and all warranty rights.

- **Make sure that the maximum short circuit current of each DC input is less than inverter allowable limit.**
- **Make sure that the maximum open voltage of each string is less than 600V. Voltage over 600 V can damage the inverter.**
- **Make sure that the impedances between the positive terminal of the PV string and Earth, and the impedances between the negative terminal of the PV string and Earth are larger than 200 K Ω in any case.**

5.4.1 PV Input Configuration

-S Series

There is one input area with one MPP tracker. Only one input can be connected, as shown in the following figure.

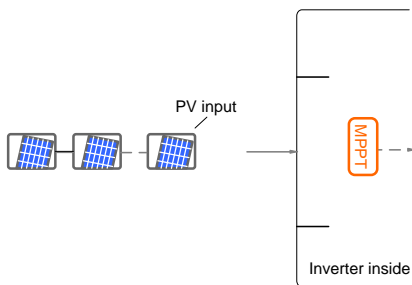

Type	Total PV Input Power Limit	Open-circuit Voltage Limit	Short-circuit Current Limit
SG2K-S	3000 W	600 V	12 A
SG2K5-S	3200 W	600 V	12 A
SG3K-S	4000 W	600 V	12 A

-D Series

There are two PV input areas, each with its MPP tracker. The two PV inputs can be configured in independent mode or parallel mode.

- Independent Mode

The two PV inputs work independently, each with its own MPPT. The two PV inputs can be different from each other in PV module types, numbers of PV panels in PV string, tilt angles and orientation angle of PV modules.

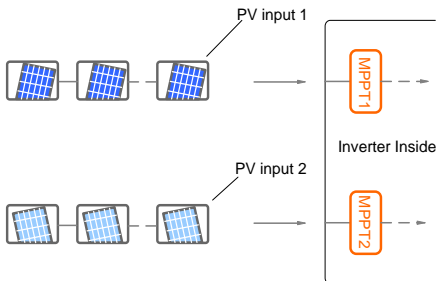

Prior to connecting the inverter to PV inputs, the specifications in the following table should be met:

Type	Total PV Input Power Limit	Open-circuit Voltage Limit (PV1 / PV2)	Short-circuit Current Limit (PV1 / PV2)
SG3K-D	4000 W	600 V/600 V	12 A/12 A
SG5K-D	6500 W	600 V/600 V	12 A/12 A



Only the current is limited for a single input and the power is not limited.

- Parallel Mode

All PV strings should have the same type, the same number of PV panels, identical tilt and identical orientation.

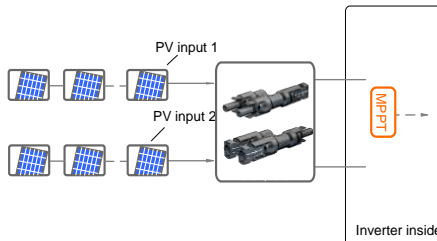

Prior to connecting the inverter to PV inputs, the specifications in the following table should be met:

Type	Total PV Input Power Limit	Open-circuit Voltage Limit	Short-circuit Current Limit
SG3K-D	4000 W	600 V	24 A
SG5K-D	6500 W	600 V	24 A



To avoid the input power unbalance of the two inputs or input load-restriction, ensure the two PV input cables are of the same type.

5.4.2 Assembling the PV Connector

All PV cables are equipped with the water-proof direct plug-in connectors which match the PV terminals at the bottom of the inverter.

NOTICE

The PV cables must be multi-stranded wires.

To ensure the protection degree IP65, only use the connectors delivered or connectors with the same degree of protection.

The requirements of PV cables are as follows.

Cross-section	Cable Diameter	Max. Withstand Voltage	Max. Withstand Current
4 mm ² –6 mm ²	6 mm–9 mm	600 V	Same with short-circuit current

Procedure:

- Strip the insulation from the cables by 7 mm.
- Assemble the cable ends by crimping pliers.

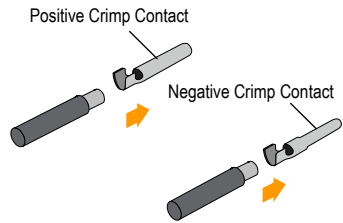
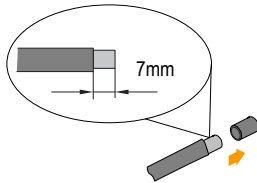

- Lead the cable through cable gland, and insert into the insulator until it snaps into place. Then tighten the cable gland (torque 2.5 N·m to 3 N·m).

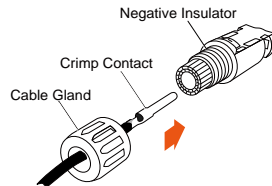
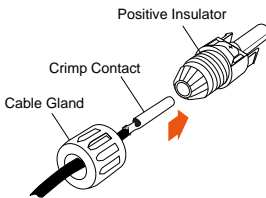

- Make sure that the cable polarities of the PV string are correct.

NOTICE

The inverter will not function properly if the PV polarities are reversed.

If the PV connectors are not assembled into place, it may cause an arc or overheat. The loss caused by this issue will void the warranty.

5.4.3 Installing the PV Connector

Connect the inverter to PV strings according to the following procedure.

1. **(Optional)** If you purchase the DC switch, rotate it to “OFF”.

Optional

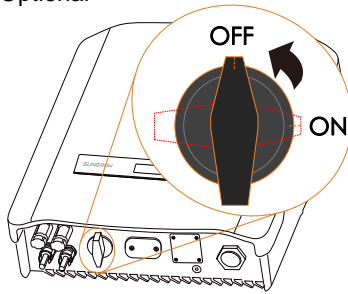

2. Check the connection cable of the PV string for the correct polarity and that the open-circuit voltage does not exceed the inverter input limit of 600 V, even under the lowest operating temperature. Refer to the module specification supplied by the module manufacturer for detailed information.

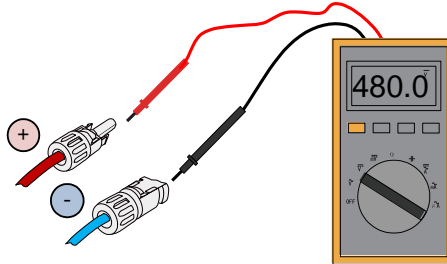

NOTICE

The inverter will not function properly if the DC polarities are reversed.

Check the positive and negative polarities of the PV strings before installation.

3. Plug the positive and the negative PV connectors into corresponding terminal until there is an audible click.

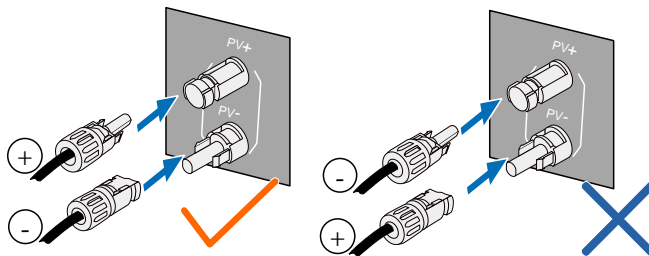

* The image shown here is for reference only. The actual product you receive may differ.

- 4. (-D series) Seal the unused PV terminals with the terminal caps.

5.5 RS485 Connection

For the Wi-Fi installation, see the last step in section “4.3 Installing the Inverter”.

NOTICE

The RS485 terminal can also be used to connect an external RS485 device. For the pin definition and waterproof procedure, please contact SUNGROW.

Failure to comply with the requirements of wiring or waterproof will void the warranty.

5.6 Meter Connection

The SUNGROW single-phase energy meter should be installed next to the main switch.

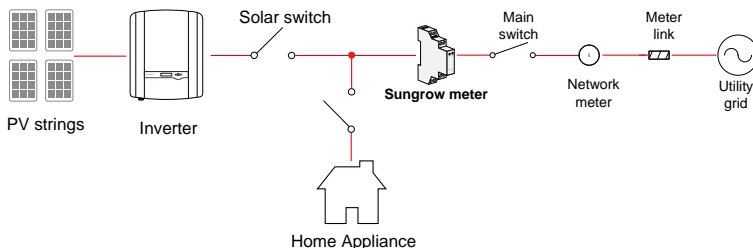

5.6.1 On the Meter Side

For Single-phase Energy Meter

1. Take out the communication connector, four M4x10 screws and washers from inverter's packaging, and the meter (with 1-phase sensor) and cables from the meter's packaging.

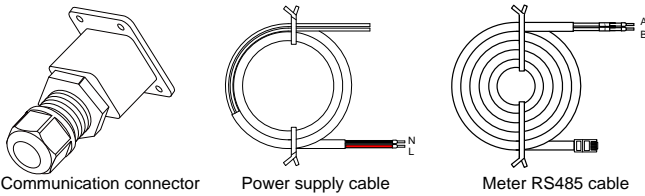

2. Unscrew the swivel nut from the cable gland and remove the waterproof plug from the left inlet. Lead the **A** and **B** plugs from inside out through the connector. This will result in the cable with the RJ45 plug on the inside end, and the **A** and **B** plugs on the outside.

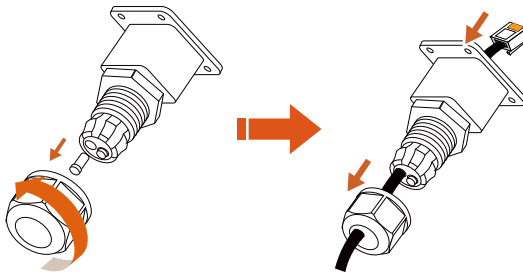

3. Connect the cables to the meter.
 - (a) Tighten the power supply wires to terminal **3 (L)** and terminal **6 (N)**.
 - (b) Tighten the RS485 wires to terminal **2** and terminal **5**.
 - (c) Place the 1-phase sensor around the phase wire (**L**) from the main switch.

The CT clamp of 1-phase sensor can be placed before or after the main switch.

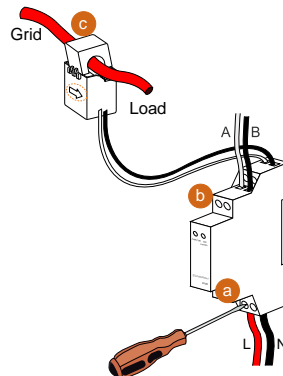

NOTICE

Make sure that the CT clamp of 1-phase sensor is installed in the right direction: the arrow on the sensor must point away from the grid towards the load.

For Three-phase Energy Meter

1. Take out the communication connector, four M4x10 screws and washers from inverter's packaging, and the meter and RS485 cable from the meter's packaging.

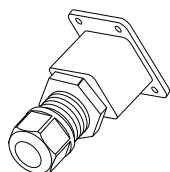

Communication connector

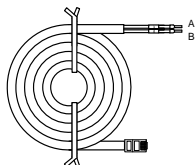

Meter RS485 cable

2. Unscrew the swivel nut from the cable gland and remove the waterproof plug from the left inlet. Lead the **A** and **B** plugs from inside out through the communication connector. This will result in the cable with the RJ45 plug on the inside end, and the **A** and **B** plugs on the outside.

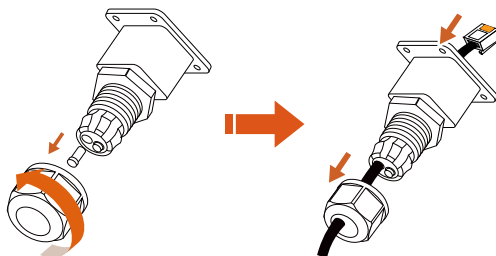

3. Connect the **A** and **B** plugs to terminals A and B on the Energy Meter, as shown below.

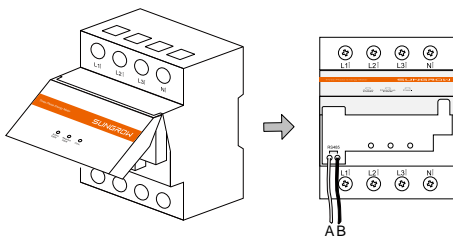

- Strip the insulation from the power wires by 10 mm. Then connect the wires to the terminals on the Energy Meter, as shown below. (Cross-section: 10 mm² to 25 mm²)

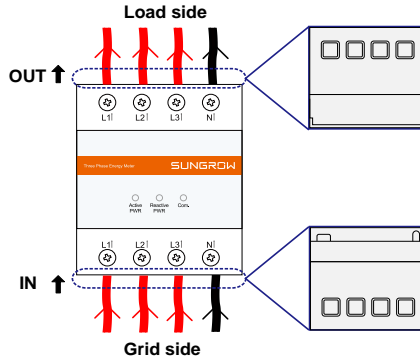

- The line conductor L1 supplies power to the Energy Meter. At least the line conductor L1 and the neutral conductor must be connected to switch on the Energy Meter.
- Just connect the line conductor L1 and the neutral conductor, then the three-phase Energy Meter can be used as a single-phase meter.

5.6.2 On the Inverter Side

Proceed as follows to connect the RS485 wires to the inverter.

- Loosen the screws and remove the waterproof lid from the **RS485|DRM** terminal.

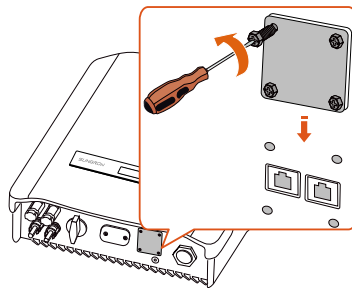

2. Insert the RJ45 plug into the left (Meter) port until it makes a clicking sound.

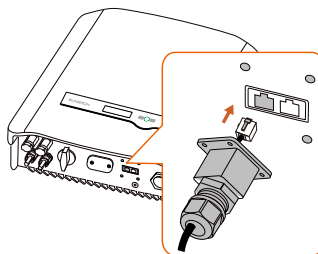

3. If no external demand response enabling device connected, secure the waterproof lid to the inverter bottom with four screws and then fasten the cable gland.

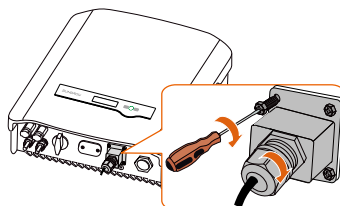

5.7 DRM Connection to an External Device

The cable for connecting to the DRED is not included in the delivery.

Use a TIA/EIA 568B standard network cable with a diameter of 3 mm–5.3 mm.

1. Take out the communication connector, four M4x10 screws and washers from the packaging, as shown on the right.
2. Loosen the screws and remove the waterproof lid from the **RS485|DRM** terminal.

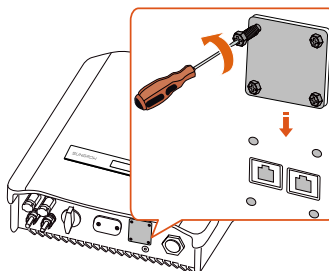
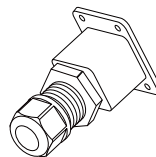

- Unscrew the swivel nut from the cable gland and remove the waterproof plug from the right inlet. Lead the cable through the cable gland then the right inlet.

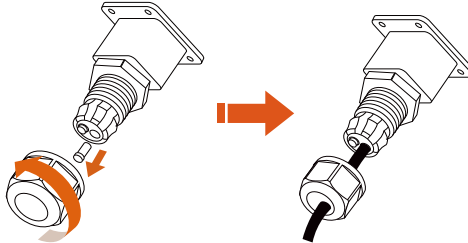

- Use the Ethernet crimper to crimp the cable and carefully push all 8 unstripped colored wires into the RJ45 plug according to TIA/EIA 568B standard, as shown below.

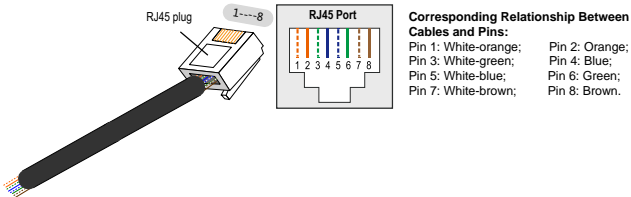

- Insert the RJ45 plug into the right port (DRM) until it makes a clicking sound.

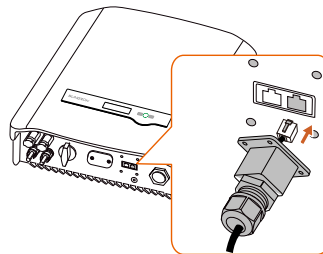

- Secure the waterproof lid to the inverter bottom with four screws and then fasten the cable gland.

- Connect the other end to the external device.

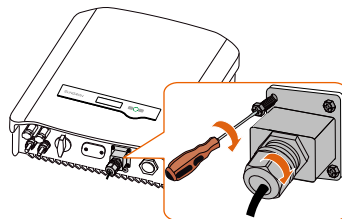

6 Commissioning

Commissioning is essential for the system, which can protect it against fires, injury and electric shock.

6.1 Inspection before Commissioning

Check the following items before starting the inverter:

1. All the installation sites are convenient for operation, maintenance and service.
2. Check and confirm that the inverter is firmly installed.
3. Space for ventilation is sufficient for one inverter or multiple inverters.
4. Nothing is left on the top of the inverter or battery pack.
5. The inverter and accessories are correctly connected.
6. Cables are routed in a safe place or protected against mechanical damage.
7. The selection of the AC circuit breaker is optimal.
8. The terminals that are not used underneath the inverter are sealed.
9. Warning signs and labels are suitably affixed and durable.

6.2 Button Function

Inverter offers two buttons with multiple functions. Please refer to the following table before any operation of the inverter.

Tab. 6-1 Button function

Button	Operation	Description
ESC	≤ 1.2 s	Navigate up / down or change the setting values. Hereinafter referred to as " Touch ESC ".
	> 1.2 s	Return to a previous menu or cancel the settings. Hereinafter referred to as " Press ESC ".
ENT	≤ 1.2 s	Move left or right, or turn pages, or view the active error/warning from the main screen. Hereinafter referred to as " Touch ENT ".
	> 1.2 s	Enter the sub-menu or confirm a selection or settings. Hereinafter referred to as " Press ENT ".

6.3 Commissioning Procedure

Make sure all the above mentioned items meet the requirements.

1. Connect the external AC circuit breaker.
2. **(Optional)** Rotate the DC switch to “ON”.
3. If there is sufficient sunlight, the inverter will enter the running state and start to feed AC power to the grid. The LCD screen will be activated 5s later.

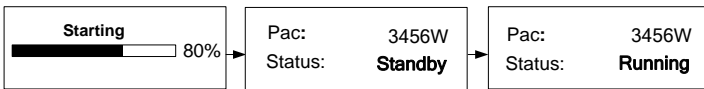

4. Observe the status of the indicator.

Tab. 6-2 Indicator Status Description

Status		Description
Green	Steady on.	The inverter is running normally, or with a warning, or with power limitation. Inverter status: Running, DRMx.
	Flash once every 1s.	The inverter is in the status of standby, startup or Turn off (via LCD menu).
Red	Steady on.	Inverter faults.
	Flash quickly every 0.2s.	Grid faults.
	Flash slowly every 1s.	PV faults.
Orange	Steady on.	The inverter is upgrading.

For the indicator explanation for the communication module, see the manual for it.

5. Visit www.solarinfobank.com or SolarInfo Home App to view inverter information. Refer to quick guide for the communication module for details.

7 LCD Operation

7.1 Button Function

Inverter offers two buttons with multiple functions. Please refer to the following table before any operation of the inverter.

Tab. 7-1 Button function

Button	Operation	Description
ESC	≤1.2 s	Navigate up / down or change the setting values. Hereinafter referred to as " Touch ESC ".
	> 1.2 s	Return to a previous menu or cancel the settings. Hereinafter referred to as " Press ESC ".
ENT	≤1.2 s	Move left or right, or turn pages, or view the active error/warning from the main screen. Hereinafter referred to as " Touch ENT ".
	> 1.2 s	Enter the sub-menu or confirm a selection or settings. Hereinafter referred to as " Press ENT ".

CAUTION

Risk of burns due to hot components!

DO not touch the hot parts (such as heat sink) during operation. Only the buttons and the optional DC switch can be touched.

7.2 Main Screen

After successful commissioning, the LCD screen will enter the main screen.

Pac:	3456W	— Inverter power
Status:	Running	— Inverter status

If there is no button operation for:

- 1 minute, LCD backlight will be automatically deactivated;
- 2 minutes, system will return to the default menu (main screen).

When there is no button operation for 8 seconds on the main screen, the LCD screen will automatically display through the main screen and energy, PV and grid interfaces, with each interface stayed for 2 seconds. Quit this mode by any operation on any button.

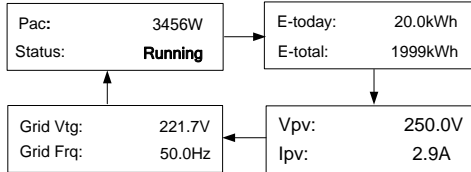

* The images shown here are for your reference only. For –D series, both PV1 and PV2 will be displayed.

Tab. 7-2 Status Description

State	Description
Standby	The inverter waits for sufficient sunlight, then the DC voltage recovers.
Startup	The inverter is initializing and synchronizing with the grid.
Running	After being energized, the inverter tracks the PV strings' maximum power point (MPP) and feeds the AC power to grid. This mode is the normal mode.
DRMx	The inverter is connected to an external demand response enabling device and the DRM switch is set to ON via the LCD menu.
Turn off	The inverter will stop running by manual "OFF" via the LCD menu or with the DRM0 command from external DRED. Set to "ON" if you want to restart the inverter.
Upgrading	The DSP or LCD program is upgrading.
Error xxx	If an error occurs, the inverter will automatically stop operation, trigger the AC relay and show "Error xxx" on the LCD with the indicator red (xxx is the error code). Once the error is cleared in recovery time, the inverter will automatically resume running. The recovery time can be set via the App.

NOTICE

If the device is in standby mode for more than 10 minutes, please check:

- Whether the insolation is sufficient and the PV connection is correct.
- If no anomaly is found, disconnect the DC switch and the main switch to restart.
- If it still does not work, contact **SUNGROW**.

Viewing the Active Error/Warning

If the status on the main screen is “Error xxx”, **Touch ENT** to view the active error code.

If the inverter is running with a warning, **Touch ENT** to view the active warning code.

Only one error or warning can be displayed on this screen. Refer to “8.1 Troubleshooting” for a solution.

Error	010
or	
Warning	514

7.3 Menu Structure

For the running information, the power value indicated represents the average value during the time interval.

The energy yields displayed are indicative only. For the actual yields, please refer to the energy meter of electric utility company.

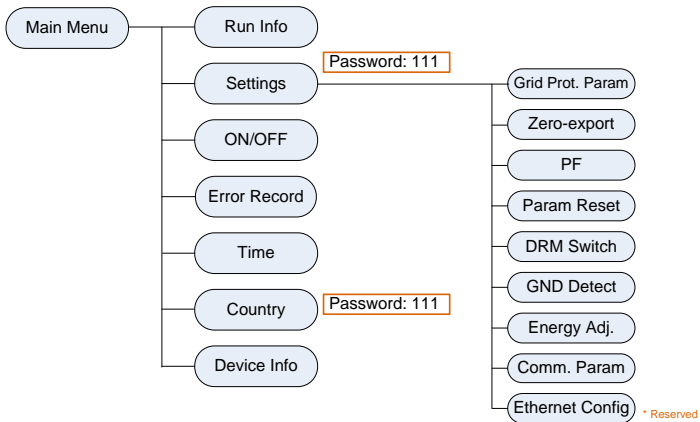
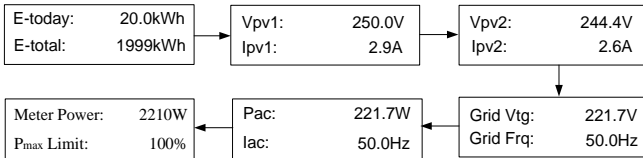

Fig. 7-1 LCD Menu Tree

7.4 Viewing Running Info

Proceed as follows to look through the detailed running information.

Main Screen (Press ENT)→Menu→Run Info (Press ENT)
 Scroll pages by touching ENT / ESC.



Meter power:

+ (omitted): The inverter is sourcing power to the grid.

-: The inverter is sinking power from the grid.

P_{max} limit: only indicated for the derating in the event of over-temperature, overvoltage or over-frequency.

7.5 Advanced Settings

7.5.1 Inputting the Password

The parameter settings are protected with a password. If you want to set the inverter’s parameters, you have to input the correct password.

Main Screen (Press ENT)→Menu (Touch ESC × 1)→Settings (Press ENT)

Touch ESC to add the value and
Touch ENT to move the cursor.
 Input the password **111**.

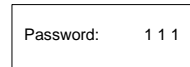

Press ENT to confirm the password and enter the submenu.
Touch ESC to navigate down and **Press ENT** to confirm.

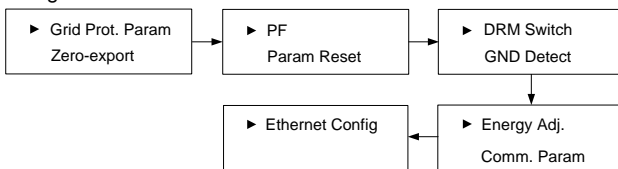

7.5.2 Setting Protective Parameters

Protective parameters are designed for the threshold values that can trigger the protective function of the inverter. The threshold values are compliant with the requirements of local safety standards and the utility grid.

If the protection function is triggered, the inverter will automatically disconnect from the grid with the "Error xxx" state displayed on the LCD main screen. After the grid voltage or frequency recovers to the specified range, the inverter will start running normally and can connect to the grid.

Touch ESC to choose the item and **press ENT** to enter the setting interface.

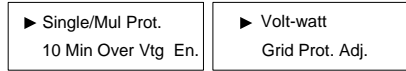

Single/Multiple Protection

Touch ESC to change the value and **touch ENT** to move the cursor. Confirm settings by **pressing ENT**. Confirm settings and scroll pages by **pressing ENT**.

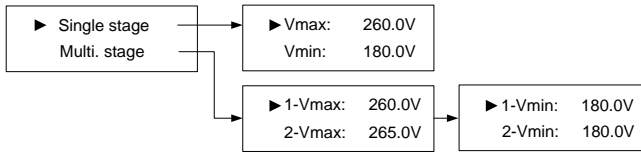

Tab. 7-3 Protective Parameters and the Range

Parameter	Explanation	Range
V_{max}	Grid over-voltage	230.0 V–277.0 V
V_{min}	Grid under-voltage	179.0 V–230.0 V
1- V_{max}	Grid over-voltage 1 (V>)	230.0 V–277.0 V
2- V_{max}	Grid over-voltage 2 (V>>)	230.0 V–277.0 V
1- V_{min}	Grid under-voltage 1 (V<)	179.0 V–230.0 V
2- V_{min}	Grid under-voltage 2 (V<<)	179.0 V–230.0 V

* Refer to **Tab. 7-7** for the default values of the parameters.

NOTICE

Too high grid voltage may affect the normal usage and the life of household loads. The loss of any or all the warranty rights may follow if the protection set-point is beyond the specified range.

10-Minute Over-voltage Protection

ON: enable the protection function by default. The inverter will automatically disconnect from the grid within 3 s when the average voltage for a 10 min period exceeds the set-point of *10 Min Over Vtg*.

Disable: turn off the function.

Range: 244.0 V–258.0 V

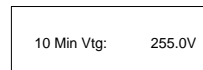

The default value of 10 Min Over Vtg is 255.0 V for Australia (code “AU”) and 248.0 V for New Zealand (code “NZ”).

Volt-watt Response

The Volt-watt response mode is enabled by default.

Set four grid voltage reference values. The output power of the inverter will vary in response to the grid voltages.



Tab. 7-4 “Volt-watt” Mode Parameter Explanations

Parameter	Explanation	Default		Range
		AU	NZ	
V1 Ref.	Grid voltage reference value 1	207.0 V	207.0 V	Not applicable
V2 Ref.	Grid voltage reference value 2	220.0 V	220.0 V	216 V–230 V
V3 Ref.	Grid voltage reference value 3	250.0 V	244.0 V	235 V–255 V
V4 Ref.	Grid voltage reference value 4	265.0 V	255.0 V	244 V–265 V

The response curve is defined by the voltage reference values and corresponding power levels.

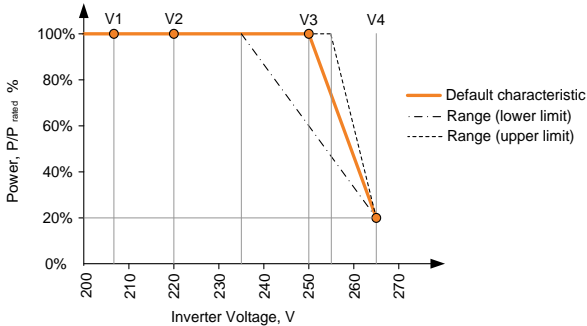

Fig. 7-2 Volt-watt Response Curve (“AU” for example)

Grid Protection Voltage Adjusting

All Sungrow’s inverters are compliant with the standard AS/NZS 4777 related to grid protection requirements. In order to work with unstable grid, inverters are equipped with automatic protection voltage adjusting function (disable by default) and this mode is available to enable by the LCD setting.

OFF (by default): the function is disabled. The grid protection voltage cannot automatically adjust.

ON: enable the protection function. The inverter will automatically adjust the protection threshold to a higher value so as to be normally connected to the grid in the event of grid over-voltage.

If the setting is changed from **ON** to **OFF**, you should set the protection voltage as specified in **Tab. 7-3** according to actual protection requirements.



NOTICE

If the automatic protection voltage adjusting function is set to ON, the volt-watt response and the 10-minute over-voltage protection function will be automatically disabled.

If the line voltage or frequency goes outside pre-determined parameters, the inverter must shut down for safety purposes, which means it is not a faulty inverter in these instances. High line voltages may damage home appliances and Sungrow is not held responsible or liable for these issues.

7.5.3 Zero-export Setting

Touch **ENT / ESC** to select and **press ENT** to confirm.

OFF: all the power will be exported to the grid.

ON: no power will be exported to the grid.

Partial: part of the export power will be exported to the grid.

Touch **ESC** to change the value and **touch ENT** to move the cursor. **Press ENT** to confirm the export power percentage.

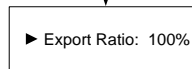
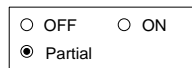

A prompt will appear when you set it for the second time.

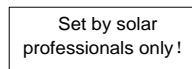

NOTICE

With the password 111, the zero-export setting can only be done at the first time. The later modification can be performed by professionals only, please contact SUNGROW.

7.5.4 PF Setting

The inverter is capable of operating with fixed power factor. The PF ranges from 0.8 leading (+) to 0.8 lagging (-).

+ (Leading): the inverter is sourcing reactive power to the grid.
- (Lagging): the inverter is sinking reactive power from the grid.



7.5.5 Parameter Reset

NOTICE
All the parameters will return to the default values except the protective parameters and time once the “Param Reset” operation is performed.

Press **ENT** to confirm the operation.
 Press **ESC** to discard the operation.

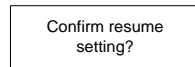

7.5.6 DRM Switch Setting

Touch **ENT / ESC** to select and **press ENT** to confirm.
ON: enable the DRM function.
OFF: disable the DRM function. (By default)



7.5.7 GND Detection

Touch **ENT / ESC** to select and **press ENT** to confirm.
 Select **ON** to enable the GND Detection. If the enclosure of the inverter is not grounded, the error code 106 will be shown on the main screen. The buzzer inside will sound at the same time.



7.5.8 Energy Adjustment

If the accumulative value “E-total” displayed on inverter screen is different from the value indicated on the metering device, you should adjust the energy deviation.

$$(\text{Energy Adj. value}) = (\text{Real measured value}) - (\text{E-total reading value})$$

Touch **ESC** to add the value and **Touch ENT** to move the cursor. **Press ENT** to confirm the setting.
 The “+” can be changed to “-” by **touching ESC**.
 The adjustment ranges from -9999 kWh to +9999 kWh.

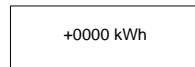

7.5.9 Setting Communication Parameter

Touch **ESC** to set the appropriate value and **touch ENT** to move the cursor. Confirm settings by **pressing ENT**.
 Device address range: 1-247.

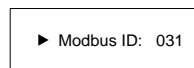

7.5.10 Ethernet Configuration

The Ethernet setting is reserved for later usage.

Touch ENT to select and **press ENT** to confirm.

OFF: The IP address should be assigned manually.

ON: Automatically assign IP address from the home router so as to access to the Internet.

Touch ESC to switch between the DHCP and the IP interfaces.

▶ DHCP:
 OFF ON

↓

▶ IP:
 192.168.001.100

7.6 Starting/Stopping the Inverter

Main Screen (**Press ENT**) → Menu (**Touch ESC × 2**) → ON/OFF (**Press ENT**)

Touch ENT / ESC to select and **press ENT** to confirm.

ON OFF

Confirm your selection by **pressing ENT**.

Confirm turn on?

Confirm turn off?

7.7 Viewing the Error Record

Main Screen (**Press ENT**) → Menu (**Touch ESC × 3**) → Error Record (**Press ENT**)

Scroll pages by **touching ENT / ESC**.

3 records can be displayed on each page and 20 records at most for all.

Press ESC to exit.

				P1/7	
1	15/01/21	09:10:12	010		
2	15/01/21	09:10:08	004		
3	15/01/21	09:11:08	005		

7.8 Setting the Time

The correct system time is very important. If there is deviation between the system time and the local time, the inverter will not operate normally. The clock is in 24-hour format.

Main Screen (**Press ENT**)→Menu (**Touch ESC × 4**)→Time (**Press ENT**)

DD, **MM**, and **YY** stand for day, month, and year respectively.

hh, **mm**, and **ss** stand for hour, minute, and second respectively.

Scroll pages by **pressing ENT**.

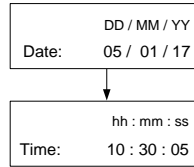

7.9 Setting the Country

To make the protection parameters setting convenient, inverter provides built-in protection parameters for certain countries. The country setting is protected with a password.

Main Screen (**Press ENT**)→Menu (**Touch ESC × 5**)→Country (**Press ENT**)

Touch ESC to add the value and **Touch ENT** to move the cursor. Input the password **111**.

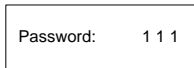

Touch ENT / ESC to choose the country and **press ENT** to confirm.

If the country selected is not in the list, please choose Other and then set the protection parameters manually.

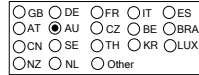

Tab. 7-5 Country Code Description

Code	Full Name	Language	Code	Full Name	Language
GB	Great Britain	English	BRA	Brazil	Portuguese
DE	Germany	German	CN	China	Chinese
FR	France	French	SE	Sweden	English
IT	Italy	Italian	TH	Thailand	English
ES	Spain	English	KR	Korea	English
AT	Austria	German	LUX	Luxemburg	German
AU	Australia	English	NZ	New Zealand	English
CZ	Czech	English	NL	Netherlands	English
BE	Belgium	English	Other	Country not included above	English

* The country code “Other” represents 50 Hz grid and 60 Hz grid. The inverter will automatically choose 50 Hz or 60 Hz according to the local grid frequency.

If the country code is set to “AU”, the grid company setting will appear. **Touch ENT / ESC** to choose the grid standard and **press ENT** to confirm.

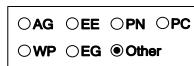

When the grid is set to “EE” or “EG”, the reactive power regulation will be in PF mode with the power factor of +0.90 (0.90 lagging).

Tab. 7-6 Grid Standard Description

Grid company Code	Company
AG	AusGrid, NSW
EE	Ergon Energy, QLD
PN	SA Power Networks, SA
PC	Powercor, VIC
WP	Western Power, WA
EG	Energex, QLD
Other	Company not mentioned above

Each grid standard code represents corresponding protective parameters that have been preset before delivery. The parameters for “Other” are applicable to Australian and compliant with the standard AS/NZS 4777.

The values listed in the following table are for your reference only. Please follow the requirements of local grid standard.

Tab. 7-7 Protective Parameters of Grid Standards

Parameter	Other (Default)	AG	EE	EG	PN	PC	WP
Over-voltage							
1- V_{\max} (V)	260.0	260.0	260.0	260.0	260.0	260.0	260.0
1-Time (s)	2.0	2.0	2.0	2.0	2.0	2.0	2.0
2- V_{\max} (V)	265.0	265.0	265.0	265.0	265.0	265.0	265.0
2-Time (s)	0.20	0.20	0.20	0.20	0.20	0.20	0.20
Under-voltage							
1- V_{\min} (V)	180.0	200.0	180.0	180.0	180.0	180.0	180.0
1-Time (s)	2.0	2.0	2.0	2.0	2.0	2.0	2.0
2- V_{\min} (V)	180.0	200.0	180.0	180.0	180.0	180.0	180.0
2-Time (s)	2.0	2.0	2.0	2.0	2.0	2.0	2.0
Over-frequency							
1- F_{\max} (Hz)	52.00	52.00	52.00	52.00	52.00	52.00	51.50
1-Time (s)	0.20	0.20	0.20	0.20	0.20	0.20	0.20
2- F_{\max} (Hz)	52.00	52.00	52.00	52.00	52.00	52.00	51.50
2-Time (s)	0.20	0.20	0.20	0.20	0.20	0.20	0.20
Under-frequency							
1- F_{\min} (Hz)	47.00	48.00	47.00	47.00	47.00	47.00	47.00
1-Time (s)	1.50	1.50	1.50	1.50	1.50	1.50	1.50
2- F_{\min} (Hz)	47.00	48.00	47.00	47.00	47.00	47.00	47.00
2-Time (s)	1.50	1.50	1.50	1.50	1.50	1.50	1.50
10-min voltage							
1- $V_{10\text{-min}}$ (V)	255.0	255.0	255.0	257.0	258.0	255.0	258.0



Refer to **Tab. 7-3** for the parameter explanation and range. If you (qualified personnel only) need to modify the voltage protective parameters, please refer to "**Single/Multiple Protection**".

7.10 Viewing Device Info

Main Screen (**Press ENT**)→Menu (**Touch ESC × 6**)→Device Info (**Press ENT**)

These interfaces show the read-only information.

Scroll pages by **touching ENT / ESC**.

Press ESC to exit.

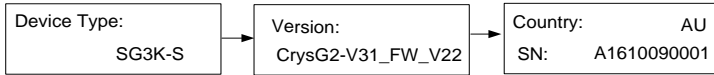

8 Troubleshooting and Maintenance

8.1 Troubleshooting

8.1.1 For the Indicator Circle

See “Tab. 6-2 Indicator Status Description” for the definition.

Fault Type	Troubleshooting
LED indicator cannot be lit.	<ol style="list-style-type: none">1. Disconnect the AC circuit breaker.2. Rotate the optional DC switch to “OFF”.3. Check the polarity of DC input.
Green indicator goes out.	<ol style="list-style-type: none">1. Disconnect the AC circuit breaker.2. Rotate the optional DC switch to “OFF”.3. Check the inverter electrical connection. Refer to “5 Electrical Connection”.4. Check whether the voltage of DC input exceeds the inverter start-up voltage.5. If all the above conditions are OK, please contact SUNGROW.

8.1.2 For the Errors on the App or LCD Screen

If the Wi-Fi module is equipped, an error icon will be shown in the App once a fault occurs. For details, see the related manual. At the same time, the “Error” state will be shown on the main screen of the inverter.

We need the following information to provide you with the best assistance:

- inverter type (e.g. string, central, grid-connected, hybrid, transformerless, single phase, triple phase, single MPPT, multiple MPPTs),
- product name,
- serial number of the inverter,
- error code / name, and
- a brief description of the problem.

Code	Description	Troubleshooting
002	Grid over-voltage. The grid voltage exceeds the protective value.	<ol style="list-style-type: none"> 1. Check the voltage of the grid. 2. If the grid voltage exceeds the permissible range of inverter protection parameters, ask utility grid company for solution. 3. If the grid voltage is within the permissible range, contact Sungrow Service Dept.
003	Transient over-voltage. The grid transient voltage exceeds the protective value.	<ol style="list-style-type: none"> 1. This is a short-term fault due to grid condition. Wait a moment for inverter recovery. 2. If the fault persists, please contact Sungrow Service Dept.
004	Grid under-voltage. The grid voltage is below the protective value.	<ol style="list-style-type: none"> 1. Check the grid voltage. 2. If the grid voltage exceeds the permissible range of inverter protection parameters, ask utility grid company for solution. 3. If the grid voltage is within the permissible range, contact Sungrow Service Dept.
005	Grid under-voltage. The grid voltage is below the protective value, which is lower than the protective value of error 004.	<ol style="list-style-type: none"> 1. This is a short-term fault due to grid condition. Wait a moment for inverter recovery. 2. If the fault persists, please contact Sungrow Service Dept.
006	AC over-current. The AC output current exceeds inverter allowable upper limit.	<ol style="list-style-type: none"> 1. The inverter will resume if the output current falls below the protection value. 2. If the fault persists, please contact Sungrow Service Dept.
007	Transient overcurrent. AC	<ol style="list-style-type: none"> 1. The inverter will self-recover after several seconds. 2. If the fault persists, please contact Sungrow Service Dept.
008	Grid over-frequency. The grid frequency exceeds the protective value.	<ol style="list-style-type: none"> 1. Check the grid frequency. 2. If the grid frequency exceeds the permissible range of inverter protection parameters, ask utility grid company for solution.
009	Grid under-frequency. The grid frequency is below the protective value.	<ol style="list-style-type: none"> 3. If the grid frequency is within the permissible range, contact Sungrow Service Dept.

Code	Description	Troubleshooting
010	Islanding	<ol style="list-style-type: none"> 1. Check whether AC circuit breaker is triggered. 2. Check whether AC cables are all firmly connected. 3. Check whether grid is not in service. 4. If all conditions are OK and this fault still occurs in the LCD screen, contact Sungrow Service Dept.
011	DC injection over-current. The DC current injection of AC current exceeds the upper limit.	<ol style="list-style-type: none"> 1. Wait a moment for inverter recovery. 2. If the fault occurs repeatedly, contact Sungrow Service Dept.
012	Leakage current over-current. The leakage current exceeds the upper limit.	<ol style="list-style-type: none"> 1. Check the PV strings for ground fault. 2. If the fault occurs repeatedly, contact Sungrow Service Dept.
014	10-minute grid over-voltage. The average grid voltage exceeds the permissible range for over 10 minutes.	<ol style="list-style-type: none"> 1. Check whether the inverter selected country code is the country you are in. 2. Wait a moment for inverter recovery. 3. Check the voltage of the grid. If the grid voltage exceeds the permissible range of inverter protection parameters, ask utility grid company for solution. 4. If the fault occurs repeatedly, contact Sungrow Service Dept.
015	Grid over-voltage The grid voltage exceeds the protective value, which is higher than the protective value of error 002.	<ol style="list-style-type: none"> 1. Check the model of the AC cables. 2. Wait a moment for inverter recovery. 3. If the grid voltage exceeds the permissible range, ask utility grid company for solution. 4. If the fault occurs repeatedly, contact Sungrow Service Dept.
016	The bus voltage or power is high.	<ol style="list-style-type: none"> 1. Wait a moment for inverter recovery. 2. If the fault occurs repeatedly, contact Sungrow Service Dept.
019	Bus transient over-voltage. The transient bus voltage exceeds the protective value.	<ol style="list-style-type: none"> 1. Wait a moment for inverter recovery. 2. If the fault occurs repeatedly, contact Sungrow Service Dept.
020	Bus over-voltage. The bus voltage exceeds the protective value.	<ol style="list-style-type: none"> 1. Wait a moment for inverter recovery. 2. If the fault occurs repeatedly, contact Sungrow Service Dept.

Code	Description	Troubleshooting
021	PV1 input over-current.	Check the layout and the wiring of PV1 input.
022	PV2 input over-current.	Check the layout and the wiring of PV2 input.
028	PV1 reverse connection.	Check the cable connections of PV1.
029	PV2 reverse connection.	Check the cable connections of PV2.
036	The temperature of radiator is too high.	1. Check whether the ambient temperature shown on the screen is too high. Wait a moment for inverter recovery. 2. Check whether there is enough space for convection.
037	The internal temperature of inverter is too high.	3. Check whether the inverter is in direct sunlight. 4. Check whether the fan is normal. Replace it if necessary. 5. Clean the air inlets. 6. If the fault persists, please contact Sungrow.
038	Relay fault on the grid side.	1. Wait a moment for inverter recovery. 2. If the fault occurs repeatedly, contact Sungrow Service Dept.
039	The insulation resistance is low. (ISO-ft)	1. Check whether there is a reliable inverter grounding line. 2. Check whether the positive and negative of PV panels is short-circuited with ground lead. 3. Wait a moment for inverter recovery. 4. If the fault occurs repeatedly, contact Sungrow Service Dept.
041	Leakage current sampling fault.	1. Wait a moment for inverter recovery. 2. If the fault occurs repeatedly, contact Sungrow Service Dept.
043	Inner under-temperature fault. The ambient temperature inside the inverter is too low.	The inverter will recover once the ambient temperature rises above -25°C.
044	Open-loop inverter self-test fault.	
045	PV1 boost circuit fault.	1. Wait a moment for inverter recovery. 2. If the fault occurs repeatedly, contact Sungrow Service Dept.
046	PV2 boost circuit fault.	
048	Phase current sampling fault.	

Code	Description	Troubleshooting
053	The slave DSP detects that the grid voltage exceeds the protective value.	<ol style="list-style-type: none"> 1. Check the grid voltage. 2. If the grid voltage exceeds the permissible range of inverter protection parameters, ask utility grid company for solution. 3. If the grid voltage is within the permissible range, contact Sungrow Service Dept.
054	The slave DSP detects that the grid frequency exceeds the protective value.	<ol style="list-style-type: none"> 1. Check the grid frequency. 2. If the grid frequency exceeds the permissible range of inverter protection parameters, ask utility grid company for solution. 3. If the grid frequency is within the permissible range, contact Sungrow Service Dept.
056	The slave DSP detects that the leakage current exceeds the protective range.	<ol style="list-style-type: none"> 1. Check whether there is a grounded fault of the PV string. 2. If the fault occurs repeatedly, contact Sungrow Service Dept.
059	Communication alarm between master DSP and slave DSP.	<ol style="list-style-type: none"> 1. Wait 1 minute for inverter recovery. 2. If the fault persists, contact Sungrow Service Dept.
061	Alarm for no inverter type setting.	Contact Sungrow Service Dept.
070	Fans are defective	Stop the inverter and disconnect the AC & DC cables. Check whether the fan duct has been blocked. If not, replace fans.
084	Warning for reverse cable connection of the Sungrow Meter.	<ol style="list-style-type: none"> 1. Check whether the power cable connections are correct. 2. For Sungrow single-phase meter, check whether the CT clamp of the 1-phase sensor is correctly placed. Refer to "5.6.1 On the Meter Side".
085	Mismatched software version.	Please contact Sungrow Service Dept.
100	The AC output current exceeds the upper limit.	<ol style="list-style-type: none"> 1. The inverter will resume if the output current falls below the protection value. 2. If the fault persists, please contact Sungrow Service Dept.
101	Grid over-frequency. The grid frequency exceeds the protective value, which is higher than the protective value of error 008.	<ol style="list-style-type: none"> 1. Check the grid frequency. 2. If the grid frequency exceeds the permissible range of inverter protection parameters, ask utility grid company for solution. 3. If the grid frequency is within the

Code	Description	Troubleshooting
102	Grid under-frequency. The grid frequency is below the protective value, which is lower than the protective value of error 009.	permissible range, contact Sungrow Service Dept.
106	The inverter is not grounded. Neither the PE terminal on the AC connection block nor the second PE terminal on the enclosure is reliably connected.	Check whether there is a reliable inverter grounding line, if there is access to the ground, and the fault persists, please contact Sungrow Service Dept.
200	Bus hardware over-voltage fault. The bus voltage exceeds the protective value.	1. Wait for inverter recovery after bus voltage lower. 2. If the fault occurs repeatedly, contact Sungrow Service Dept.
201	The bus voltage is too low.	1. Wait a moment for inverter recovery. 2. If the fault occurs repeatedly, contact Sungrow Service Dept.
202	PV hardware over-current fault. The PV1 or PV2 current exceeds the protective value.	If the fault occurs repeatedly, contact Sungrow Service Dept.
203	The PV input voltage exceeds the bus voltage.	Check the functionality of the PV connection terminals.
306	Input and output power mismatching fault.	If the fault occurs repeatedly, contact Sungrow Service Dept.
315	PV1 current sampling fault.	Channel sampling anomaly.
316	PV2 current sampling fault.	Contact Sungrow Service Dept.
320	Leakage current sensor fault.	Contact Sungrow Service Dept.
409	Both the ambient temperature sensor and the radiator temperature sensor fail.	If the fault occurs repeatedly, contact Sungrow Service Dept.
503	Ambient temperature sensor open circuit warning.	

Code	Description	Troubleshooting
504	Ambient temperature sensor short circuit warning.	
505	Radiator temperature sensor open circuit warning.	
506	Radiator temperature sensor short circuit warning.	
501	External memory reading/writing warning.	<ol style="list-style-type: none"> 1. Inverter can normally be connected to the grid. 2. Power on the inverter again. If the fault persists, contact Sungrow Service Dept.
514	Abnormal communication warning of the Sungrow Meter. (Inverter can be normally connected to the grid.)	<ol style="list-style-type: none"> 1. Check whether the power cable connections of the meter are correct. 2. Check whether the RS485 connection is correct.

8.2 Routine Maintenance

DANGER

Risk of inverter damage or personal injury due to incorrect service!

Always keep in mind that the inverter is powered by dual sources: PV strings and utility grid.

Before any service work, observe the following procedure.

- **Disconnect the inverter from the utility grid side first and then PV strings;**
- **Wait at least 10 minutes for inner capacitors to discharge completely;**
- **Verify that no voltage and current existing with appropriate testing devices.**

CAUTION

Keep non-related persons away!

A temporary warning sign or barrier must be posted to keep non-related persons away while performing electrical connection and service work.

NOTICE

Risk of inverter damage if it is improperly serviced.

Use accessories and spare parts approved by the inverter manufacturer only. Never modify the inverter or other components of the inverter. The loss of any or all warranty rights may follow if otherwise.

NOTICE

Any malfunction that may impair the inverter safety operation must be repaired immediately before the inverter is restarted.

Inverter contains no customer serviceable parts inside. Please contact local authorized personnel if any service work is required.



Servicing of the device in accordance with the manual should never be undertaken in the absence of proper tools, test equipments or the more recent revision of the manual which has been clearly and thoroughly understood.

Items	Methods	Period
System clean	Check the temperature and dust of the inverter. Clean the inverter enclosure. Check the humidity and dust of the environment. Meanwhile check whether the filter function of the air inlet is ok.	Six months to a year (it depends on the dust contents in air.)

9 System Decommissioning

9.1 Disconnecting the Inverter

For maintenance or other service work, the inverter must be switched off.

Proceed as follows to disconnect the inverter from the AC and DC power sources. Lethal voltages or damage to the inverter will follow if otherwise.

1. Stop the inverter via the LCD menu. For details, see “7.6 Starting/Stopping the Inverter”.
2. Disconnect the AC circuit breaker and secure it against reconnection.
3. Rotate DC switch to “OFF”. Disconnect the external DC circuit breaker.

NOTICE

Please strictly follow the sequence of the above procedures. Inverter will not work normally if otherwise.

4. Wait about **10** minutes until the capacitors inside the inverter completely discharge.
5. Measure to confirm that the AC output at the AC circuit breaker is voltage free.
6. Remove the AC connector. Lay the tool in the location of snap and press the tool down. Then snap can be pushed from the AC terminal.
7. Release the locking part of PV connectors by pressing on the ribbing of the locking hooks with nipper pliers and pull it outwards.

Press the ribbing



Pull outwards



Disconnect DC connectors

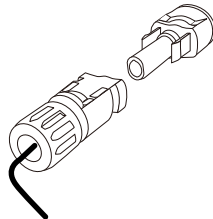

For further disconnection and conductor reconnection instruction, please visit the webpage of device manufacturer.

9.2 Dismantling the Inverter

CAUTION

Risk of burn injuries and electric shock!

Do not touch any inner live parts until at least 10 minutes after disconnecting the inverter from the utility grid and the PV input.

1. Refer to “**5 Electrical Connection**” for the inverter disconnection of all cables in reverse steps.
2. Dismantle the inverter referring to “**4 Mechanical Mounting**” in reverse steps.
3. If necessary, remove the wall-mounting bracket from the wall.
4. If the inverter will be reinstalled in the future, please refer to “**3 Unpacking and Storage**” for a proper conservation.

9.3 Disposing of the Inverter

Users should take the responsibility for the disposal of the inverter.

NOTICE

Some parts and devices of the inverter, such as the capacitors, may cause environment pollution.

Disposal of the inverter must comply with the related local regulations to avoid the potential pollution.

10 Appendix

10.1 Technical Data

10.1.1 –S Series

Parameters	SG2K-S	SG2K5-S	SG3K-S
Input Data			
Max. PV input power	3000 W	3200 W	4000 W
Max. PV input voltage	600 V		
Startup voltage	120 V		
Nominal input voltage	360 V		
MPP voltage range	90 V–560 V		
MPP voltage range for nominal power	210 V–480 V	260 V–480 V	310 V–480 V
No. of MPPTs	1		
Max. number of PV strings per MPPT	1		
Max. PV input current	10 A		
Max. current for input connector	12 A		
Short-circuit current of PV input	12 A		
Max. inverter backfeed current to PV string	0 A		
Output Data			
Nominal AC output power	2000 W	2500 W	3000 W
Max AC output apparent power	2000 VA	2500 VA	3000 VA
Max. AC output current	9.1 A	11.3 A	13.7 A
Max. inrush current (peak value / duration)	8 A / 12 ms		
Max. output fault current (peak value / duration)	80 A / 3.2 ms		
Max. output over-current protection	25 A		
Nominal AC voltage	230 Vac (single phase)		
AC voltage range	180 Vac–276 Vac (this may vary with grid standards)		
Nominal grid frequency	50 Hz / 60 Hz		
Grid frequency range	45 Hz–55 Hz / 55 Hz–65 Hz (this may vary with grid standards)		
Total harmonic distortion (THD)	<3% (of nominal power)		
DC current injection	<0.5% (of nominal current)		
Power factor	>0.99 at default value at nominal power (adj. 0.8 leading to 0.8 lagging)		

Parameters	SG2K-S	SG2K5-S	SG3K-S
Protection			
PV reverse connection protection	Yes		
AC short circuit protection	Yes		
Leakage current protection	Yes		
Anti-islanding protection	Yes (frequency shift)		
DC switch	Optional		
Overvoltage Category	III [AC], II [DC]		
Safety protection class	I		
System Data			
Max. efficiency	98.2 %	98.2 %	98.2 %
Max. European efficiency	97.2 %	97.5 %	97.7 %
Isolation method	Transformerless		
Ingress protection rating	IP65		
Pollution degree outside the enclosure	3		
Pollution degree inside the enclosure	2		
Power loss in night mode	< 1 W		
Operating ambient temperature	-25°C to +60°C		
Allowable relative humidity	0–100 %		
Cooling method	Natural cooling		
Max. operating Altitude	4000 m (derating when > 2000 m)		
Display	Graphic LCD		
Communication	Wi-Fi		
PV connection type	MC4		
AC connection type	Plug and play connector		
Certification	IEC 61000-6-2, IEC 61000-6-3, AS 4777.2, IEC 62109-1, IEC 62109-2, EN 50438, NB/T 32004, GB/T 29319, ABNT NBR 16149:2013, ABNT NBR 16150:2013		
Mechanical Data			
Dimensions (W x H x D)	300 mm x 370 mm x 125 mm		
Mounting method	Wall-mounting bracket		
Weight	8.5 kg		

10.1.2 –D Series

Parameters	SG3K-D	SG5K-D
Input Data		
Max. PV input power	4000 W	6500 W
Max. PV input voltage	600 V	
Startup voltage	120 V	
Nominal input voltage	360 V	
MPP voltage range	90 V–560 V	
MPP voltage range for nominal	160 V–480 V	260 V–480 V

Parameters	SG3K-D	SG5K-D
power		
No. of MPPTs	2	
Max. number of PV strings per MPPT (PV1/PV2)	1/1	
Max. PV input current	20 A (10 A / 10 A)	
Max. current for input connector	24 A (12 A / 12 A)	
Short-circuit current of PV input	24 A (12 A / 12 A)	
Max. inverter backfeed current to PV string	0 A	
Output Data		
Nominal AC output power	3000 W	4990 W
Max AC output apparent power	3000 VA	4990 VA
Max. AC output current	13.7 A	21.7 A
Max. inrush current (peak value / duration)	10 A / 12 ms	
Max. output fault current (peak value / duration)	100 A / 3.2 ms	
Max. output over-current protection	25 A	32 A
Nominal AC voltage	230 Vac (single phase)	
AC voltage range	180 Vac–276 Vac (this may vary with grid standards)	
Nominal grid frequency	50 Hz / 60 Hz	
Grid frequency range	45 Hz–55 Hz / 55 Hz–65 Hz (this may vary with grid standards)	
Total harmonic distortion (THD)	< 3 % (of nominal power)	
DC current injection	< 0.5 % (of nominal current)	
Power factor	> 0.99 at default value at nominal power (adj. 0.8 leading to 0.8 lagging)	
Protection		
PV reverse connection protection	Yes	
AC short circuit protection	Yes	
Leakage current protection	Yes	
Anti-islanding protection	Yes (frequency shift)	
DC switch	Optional	
Overvoltage Category	III [AC], II [DC]	
Safety protection class	I	
System Data		
Max. efficiency	98.4 %	98.4 %
Max. European efficiency	97.7 %	98.0 %
Isolation method	Transformerless	
Ingress protection rating	IP65	
Pollution degree outside/inside the enclosure	3 / 2	
Power loss in night mode	< 1 W	
Operating ambient temperature	-25°C to +60°C	

Parameters	SG3K-D	SG5K-D
Allowable relative humidity	0–100 %	
Cooling method	Natural cooling	
Max. operating Altitude	4000 m (derating when > 2000 m)	
Display	Graphic LCD	
Communication	Wi-Fi	
PV connection type	MC4	
AC connection type	Plug and play connector	
Certification	IEC 61000-6-2, IEC 61000-6-3, AS 4777.2, IEC 62109-1, IEC 62109-2, EN 50438, NB/T 32004, GB/T 29319, ABNT NBR 16149:2013, ABNT NBR 16150:2013	
Mechanical Data		
Dimensions (W x H x D)	360 mm x 390 mm x 133 mm	
Mounting method	Wall-mounting bracket	
Weight	11.5 kg	

10.2 Exclusion of Liability

The content of these documents is periodically checked and revised where necessary. Discrepancies therefore may exist. Readers are cautioned that SUNGROW reserves the right to make changes without notice. Please call us or visit our website at www.sungrowpower.com for the latest information. No guarantee is made for the completeness of these documents. Please contact our company or distributors to get the latest version.

Guarantee or liability claims for damage of any kind are excluded if they are caused by one or more of the following:

- improper or inappropriate use or install of the product;
- installing or operate the product in unintended environment;
- installing or operate the product without observing relevant safety regulations in the deployment location;
- ignoring the safety warnings or instructions contained in all documents relevant to the product;
- installing or operate the product under incorrect safety or protection conditions;
- altering the product or supplied software without authority;
- the product faults due to operation attached or neighboring devices beyond of allowed limit values; and

- damage caused by the natural environment beyond the rated operating range of the inverter.

The use of supplied software produced by SUNGROW is subject to the following conditions:

- SUNGROW rejects any liability for direct or indirect damages arising from the use of SolarInfo software. This also applies to the provision or non-provision of support activities.
- Using the SolarInfo software for commercial purposes is prohibited.
- Decompiling, decoding or destroying the original program, including SolarInfo software and the embedded software, is prohibited.

10.3 About Us

SUNGROW is a China-leading manufacturer of various power electronics products for renewable energy generation systems, supplying to a global customer base. Our products include converters, inverters, battery chargers and other power supplies for distributable generation systems in both grid-connected and stand-alone applications. The power rating of SUNGROW products covers from several hundred watt to large mega-watt systems.

The vision of Sungrow is to help our customers acquire stable and clean power with minimum cost, maximum reliability and enhanced safety.

Contact Information

Should you have any problems, please contact us through the following information. We will be more than happy to assist you!

Company:	Sungrow Power Supply Co., Ltd.
Website:	www.sungrowpower.com
Email:	service@sungrowpower.com (China), service@sungrow.cn (Overseas)
Add:	No.1699 Xiyou Rd., New & High Technology Industrial Development Zone, Hefei, P. R. China.
Post Zip:	230088
Service line:	400 119 7799 (China), +86 551 65327834 (Overseas)
Fax:	+86 551 65323478



Sungrow Power Supply Co., Ltd.

Add: No.1699 Xiyou Rd.,New & High Technology Industrial Development Zone, 230088,Hefei, P. R. China.

Post Zip: 230088

Web: www.sungrowpower.com

E-mail: info@sungrow.cn

Tel: +86 551 6532 7834/6532 7845

Fax: +86 551 6532 7856

Specifications are subject to changes without advance notice.